



APL-10

SELF-POWERED CONCERT SUBWOOFER SYSTEM

DESCRIPTION:

The APL-10 self-powered subwoofer incorporates internal amplifiers and intelligent, front-end signal processing into a robust enclosure designed for concert touring, AV presentations, and fixed installations. The dual cone drivers provide powerful, deep bass with rapid transients for a crisp, clean, and accurate sonic image.

ADVANCED TECHNOLOGIES:

Patented all-digital amplifier operating at 350 kHz provides high power levels with extremely low distortion. State-of-the-art digital processing circuits render pristine sound quality. Advanced limiter algorithms provide precise system control without harming sound quality at even the most aggressive levels. Universal AC voltage compatibility.

POWER AMPLIFIERS AND PROCESSOR:

Dual amplifiers, one per driver, with 2400W total music power

DRIVER COMPLEMENT:

Dual Apogee 15" (381mm) permanent magnet cone-type drivers are treated with a waterproofing compound, providing resistance to moisture, and enabling long-term stability of cone resonance and cone mass parameters; also treated with Ferrofluid® for greater power handling capability, lower distortion, and control of short-term impedance rise

HANDLES:

Four handles designed as an integral part of the enclosure (no moving parts)

GRILLE:

Powder-coated, diamond-punched steel with acoustic foam covering

TRIM:

Optional protective steel pieces on top and bottom edges; powder-coated for durability

RIGGING HARDWARE:

Four 12 gauge steel nutplates, mounted two on top and two on bottom, recessed so as to be nominally flush; accepts 3/8"-16 thread, nutplates are backed with 12 gauge steel internal brackets (10mm nutplate or Aeroquip™ Pan fittings optional)

ENCLOSURE TYPE:

20° trapezoidal, optimally-vented bass

CABINET CONSTRUCTION:

Multi-ply birch with stainless steel fasteners

WARRANTY:

Three (3) years, limited

ENGINEERING DATA:

FORMAT:

Self-contained dual power amplifiers with integrated processing electronics

DISPERSION:

Omni-directional

FREQUENCY RESPONSE (1M ON AXIS):

34 Hz to 100 Hz \pm 3 dB

MAX. SPL (@1M):

131 dB cont./137 dB peak

DIMENSIONS:

32" (813mm) W x 22.5" (572mm) H x
24" (610mm) D

WEIGHT:

145 lb. (65.8 kg)

ELECTRONICS SPECIFICATIONS:

INPUT:

XLR connectors, active balanced 35k ohms

LOOP-THROUGH OUTPUT:

Daisy-chain audio signal, XLR type connector

AMPLIFIER POWER:

2400W total music power, dual amplifiers

RMS LIMITER:

100 ms long duration protection

PEAK LIMITER:

3 to 5 ms fast-acting transient protection

COOLING:

Passive using external heat sinks

VOLTAGE:

115V AC or 230V AC selection switch, Neutrik Powercon™ AC inlet with loop-through; power cable included

Apogee
SOUND INTERNATIONAL

POLAR MEASUREMENTS (6 dB/division, normalized)

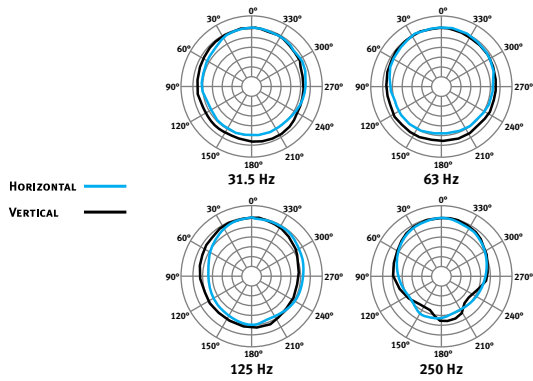

All polar measurements obtained in a free-field environment at 10° increments.

FREQUENCY RESPONSE (10 dB/division)

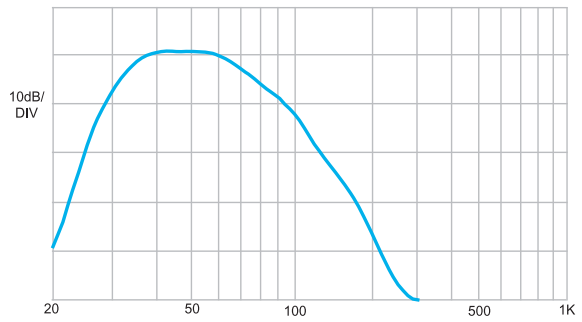

Measured in a free-field anechoic environment using a swept one-third octave input.

LINE AC PANEL

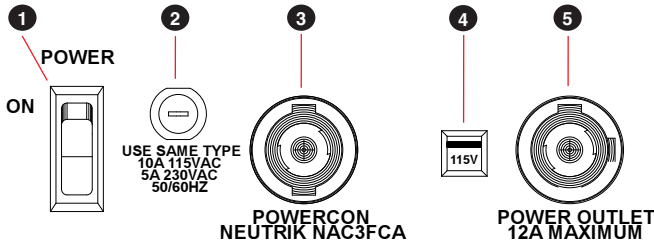

- 1 POWER SWITCH
- 2 MAIN AC PROTECTION FUSE
- 3 AC INPUT CONNECTOR, NEUTRIK POWERCON NAC3FCA
- 4 AC LINE VOLTAGE SELECTION SWITCH
- 5 AC OUTPUT CONNECTOR, NEUTRIK POWERCON NAC3FCB

AUDIO INPUT PANEL

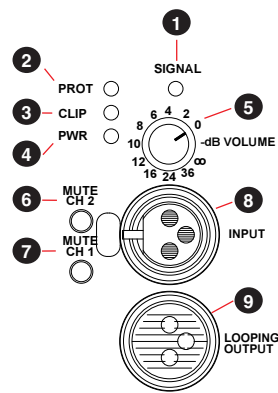

- 1 SIGNAL PRESENCE INDICATOR
- 2 SYSTEM PROTECTION INDICATOR
- 3 AMPLIFIER CLIP INDICATOR
- 4 SYSTEM POWER INDICATOR
- 5 VOLUME CONTROL
- 6 CH 2 MUTE SWITCH
- 7 CH 1 MUTE SWITCH
- 8 BALANCED LINE AUDIO INPUT, XLR
- 9 BALANCED LINE AUDIO LOOP-THROUGH, XLR

DIMENSIONAL DRAWINGS

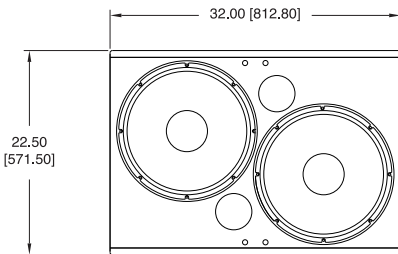

FRONT VIEW
(WITHOUT GRILLE)

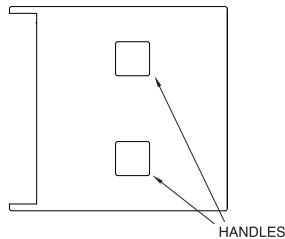

SIDE VIEW
(WITHOUT GRILLE)

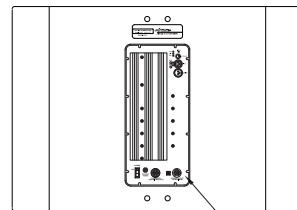

REAR VIEW

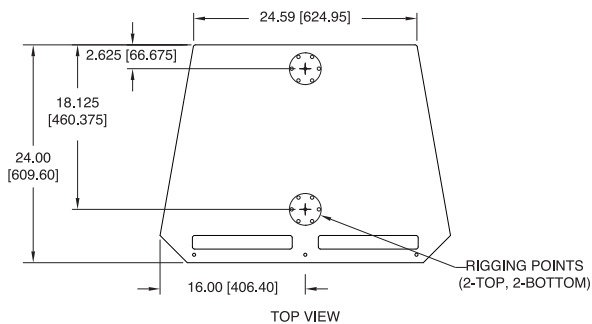

TOP VIEW

APOGEE
SOUND INTERNATIONAL

50 SPRING STREET, RAMSEY, NJ 07446, USA
TEL: 800-443-3979 • FAX: 800-999-9016 • www.apogee-sound.com